

AQUAPERFORM

USER GUIDE

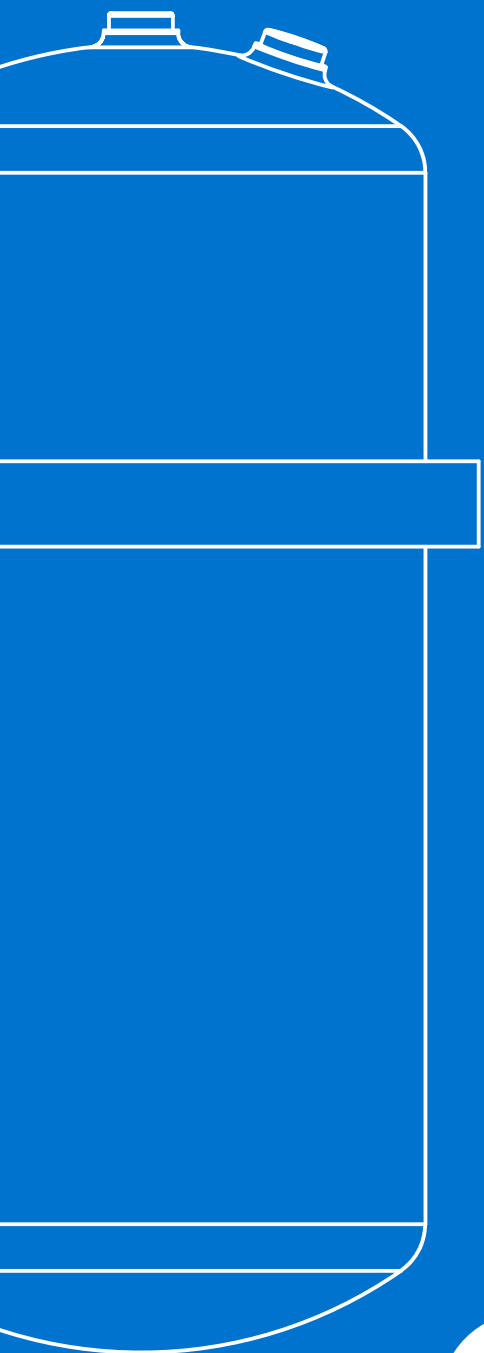

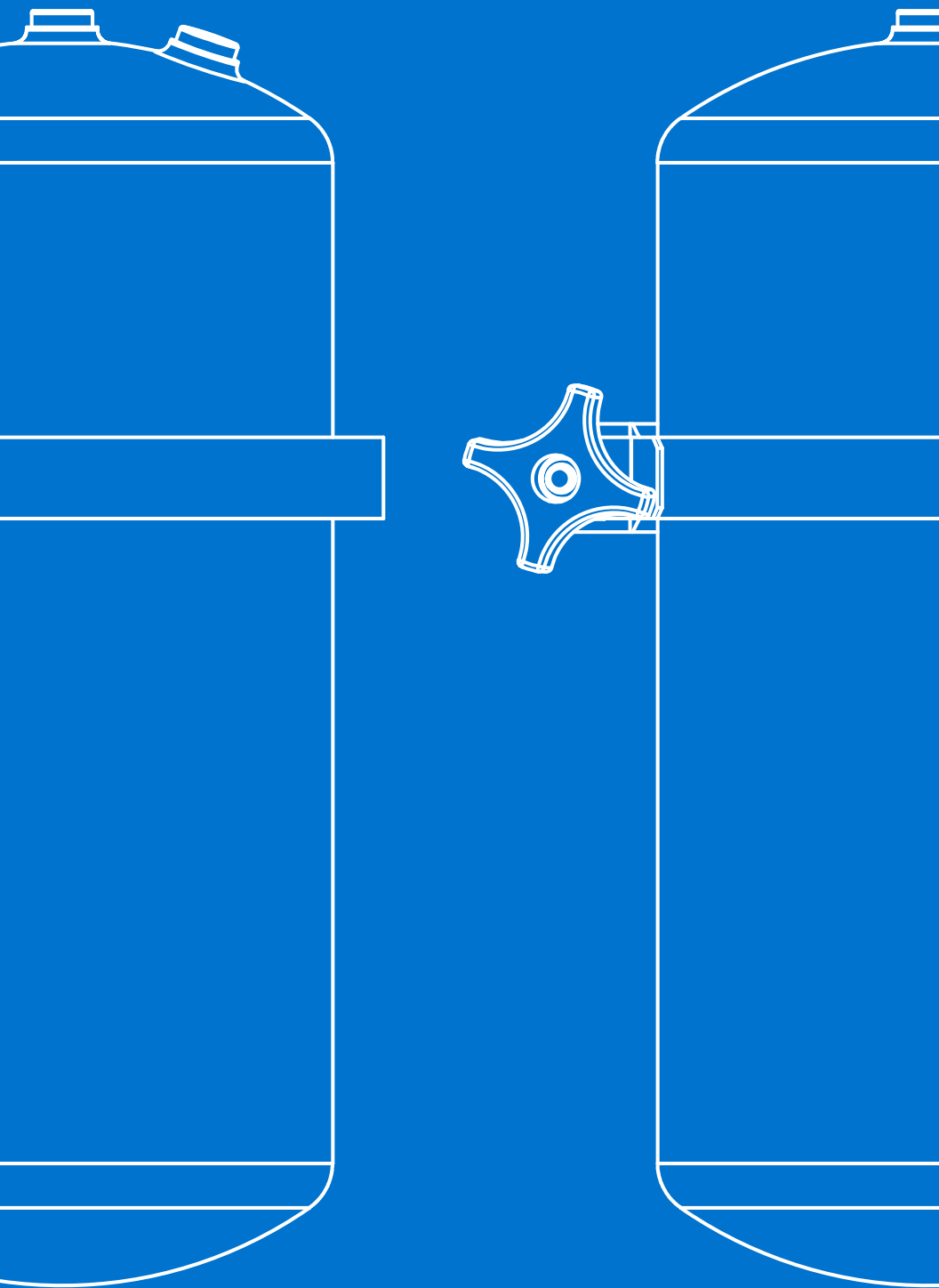

Index

About the Aquaperform	2
Aquaperform Features	2
Before You Begin	3
Aquaperform Drinking Water System Specifications	4
Inspect Your Drinking Water System	5
Install Your System	5
Prepare Your System For Use	5
Maintenance	6
• Regarding Filter Capacity	6
• Removing The Old Filter Cartridge	6
• Installing The New Filter Cartridge	7
Flushing / Disinfecting The System	8
Warranty	8
Contaminant Reduction Performance	9
• NSF/ANSI 42 - Aesthetic Effects	9
• NSF/ANSI 53 - Health Effects	9
• Arsenic Facts	11
Troubleshooting	13
Frequently Asked Questions	14
Aquaperform Accessories	16

Aquaperform User Guide

About the Aquaperform Drinking Water System

- The Multipure Aquaperform Drinking Water System (MP880) is designed for use on the countertop next to the sink, below the sink, or inline with other devices.
- The Aquaperform is third-party tested and verified by NSF under NSF/ANSI Standard 42 (Aesthetic Contaminants), Standard 53 (Health Contaminants), and Standard 401 (Emerging Compounds/Incidental Contaminants).
- If installation or operation assistance is required, please contact your Multipure Independent Distributor. If the Independent Distributor is unavailable, please contact Multipure Customer Service at 1.800.622.9206.

Aquaperform Features

- Easy and convenient to use; provides delicious, clear, healthier drinking water whenever you need it.
- Better-tasting beverages - coffee, tea, juices, and drinks of all kinds.
- Use for food preparation, improving the taste of fruits and vegetables.
- Highest quality water for cooking - better pasta, sauces, soups, etc.
- Your pets will love it too!
- Guaranteed quality backed by an outstanding customer satisfaction guarantee and warranty.
- Cost-effective solution to meet your budget and replaces costly bottled water.
- Attaches easily to your faucet without tools.
- Reliable protection for all of your family's drinking water needs.

Before You Begin

Multipure Drinking Water Systems (DWS) have been extensively tested and certified by NSF International to provide the highest level of assurance that the device will perform as claimed. Please read this manual before proceeding with the installation and use of your system. Installation, operation, and maintenance requirements are essential to the performance of your system – failure to follow any instructions or operating parameters contained herein may lead to product damage or product failure.

- Replacement filters can be purchased directly from Multipure. For the latest prices, please visit our website at www.multipure.com/store/
- Actual filter life depends on the amount of water used and the level of impurities in the water. See section **Regarding Filter Capacity (Pg 6)** for additional details.
- Multipure Drinking Water Systems are not intended for use with microbiologically unsafe water or non-municipally-treated water. Systems certified for cyst reduction may be used on disinfected waters that may contain filterable cysts. See section **Frequently Asked Questions (Pg 14)** for additional details.
- Do not allow water to freeze in the system. If the system is exposed to freezing temperatures, drain water from the system and remove the filter. Allow the filter to thaw before replacing and reusing.
- Do not allow water to sit in the system for extended periods of time (i.e., 10 days or more) without use. See section **Flushing / Disinfecting the System (Pg 8)** for additional details.
- To dispose of the used filter, remove it from the housing and place in normal refuse. Filters disposed in a normal landfill will not release any chemical contaminants and may continue to adsorb additional contaminants in the landfill.

Aquaperform Drinking Water System

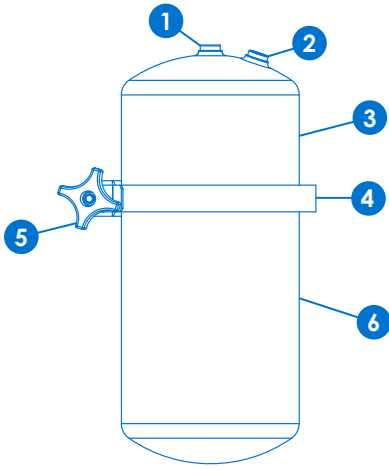

- 1. Outlet
- 2. Inlet
- 3. Housing Top
- 4. V-Band
- 5. V-Band Knob
- 6. Housing Bottom

Specifications

Model Name:	Aquaperform (MP880)
Approximate Filter Capacity:	600 Gallons
Replacement Filter Type:	CB11As
Approximate Flow Rate:	1.0 gpm @60 psi
Pressure Vessel Composition:	Stainless Steel
Rubber Items:	Silicone
Outlet:	1/8" NPT
Inlet:	1/8" NPT
Working Pressure Range:	30 psi (2.1 kg/cm ²) to 100 psi (7.0 kg/cm ²)
Operating Temperature Range:	32° F (0° C) to 100° F (38° C) - for cold water use only
Particle Retention Size:	0.5 micron (sub-micron)
Certified By:	NSF International

Inspect Your Drinking Water System

Before setting up and connecting your Aquaperform, inspect your DWS to confirm that it has been received in good condition and that all parts are included.

Install Your System

The Aquaperform can be installed below the sink with a below-sink kit or on the countertop with a countertop kit. Please refer to the appropriate Installation Guide included with an Install Kit for step-by-step instructions.

The Aquaperform can be used inline for connection to refrigerators, water coolers, or ice makers, so that all of the water from the cold water outlet or faucet is filtered. Multipure recommends that a professional plumber install the system for inline use.

Prepare Your System for Use

1. Using a paper towel or cloth, dry off all connections and the system housing.
2. Make sure that all connections are tightly secured.
3. Remove any air and loose carbon from the system.
 - a. Allow water to flow through the DWS for 30 minutes. This purges any air and loose carbon from the system.
 - b. Adjust the water supply so that the water flow to the drinking water faucet does not exceed the flow rate of 1.0 gallons per minute.

NOTE: It takes approximately 15 seconds to fill a quart at a flow rate of 1.0 gallons per minute.
4. Check all connections to make sure that there are no leaks.
5. **Congratulations! Your system is now ready for use!**

Maintenance

Regarding Filter Capacity

1. Exact filter capacity varies in proportion to the amount of water used and the level of impurities in the water being processed. For contaminants reduced through physiochemical adsorption, the filter capacity is 600 gallons. For contaminants reduced through mechanical filtration, capacity claims are inapplicable due to broad variations in the quality and quantity of physical matter in the drinking water. Excessive physical matter will cause the Aquaperform to clog, diminishing flow rate but reducing the contaminants from the resultant water stream.
2. For optimum performance and to maintain the lifetime warranty on your system housing, it is essential that the filter be replaced when the first of the following occurs:
 - a. Annually
 - b. When the system is near or has reached its rated capacity
 - c. When the flow rate diminishes
 - d. When the filter becomes saturated with bad tastes and/or odors

Removing the Old Filter Cartridge

1. Before opening the Aquaperform housing, place a pan or basin beneath the housing.
2. Stop the water supply and relieve the water pressure in the Aquaperform.
3. If the system is mounted on a bracket, leave the system mounted on the bracket.
4. With the Aquaperform housing in an upright position, unscrew the black knob on the Locking V-Band by turning it counter-clockwise.
5. With the black knob removed, spread the Locking V-Band apart and let it drop off the bottom of the Aquaperform. Carefully set it aside.
6. Remove the bottom half of the Aquaperform by sliding it off. Make sure that the black O-ring remains in place on the bottom half of the housing.

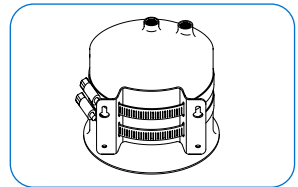

7. Remove the old filter cartridge from the top half of the housing by rotating it counter-clockwise (if facing the inside of the top half of the housing).
8. Dispose of the used filter cartridge in your waste container.
9. Rinse out the inside of the system housing, hand washing if necessary.
10. Inspect the black rubber cushion on the inside of the top half of the housing, making sure that it is not cracked or worn; Multipure recommends that the cushion be replaced every two to three years.

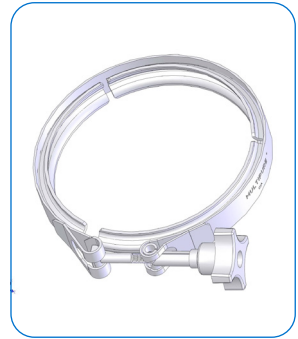

Installing the New Filter Cartridge

1. If you have not done so already, remove the plastic wrapper and instruction wrap from around the new filter cartridge.
2. Align the threaded hole of the new filter cartridge onto the inside thread of the top half of the Aquaperform. Rotate the cartridge clockwise to tighten (if facing the inside of the top half of the housing). Make sure that the cartridge is threaded properly and straight. **DO NOT OVERTIGHTEN.**
3. Reconnect the top half of the housing (with attached filter cartridge) with the bottom half. Replace the Locking V-Band, making sure the screw is in place to connect the band together.
4. Screw the black knob onto the Locking V-Band, turning it clockwise to tighten.
5. Make sure that the V-Band is tightly secured evenly around the housing top and bottom.
6. To resume normal use of the Aquaperform, proceed to section **Prepare Your System for Use (Pg 5)**.

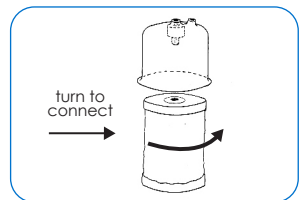
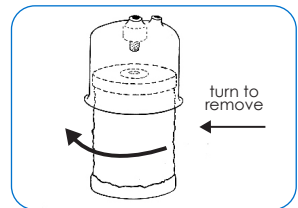

Flushing / Disinfecting the System

Multipure recommends that you not allow water to sit in the system for extended periods of time without use. If a system is left unused for more than 10 days, it may need to be flushed / disinfected before resuming normal use.

1. Remove the filter cartridge by following the directions in **Removing the Old Filter Cartridge (Pg 6)**.
2. Add 5 to 7 drops of bleach to the bottom half of the system.
3. Reconnect the top half of the housing without a replacement filter cartridge installed.
4. Turn on the water supply and allow the system to fill up with the water/bleach solution.
5. Let the water and bleach flush out of the system.
6. Open, clean, and rinse out the inside of the system.
7. Follow the directions in section **Installing the New Filter Cartridge (Pg 7)**.

Warranty

Multipure 90-Day Guarantee: Multipure is confident in the performance of its Drinking Water Systems (DWS). If you should find this Drinking Water System unsatisfactory, let us know within 90 days of purchase for a prompt exchange or refund.

Multipure Warranty: Multipure warrants to the original retail customer its DWS and components to be free of defects in material and workmanship for use under normal care, and will repair or replace any system at no charge (excluding transportation to Multipure Corporate Headquarters) to the customer during the warranty period. The DWS housing is warranted for a lifetime (provided the filter has been changed at least once per year); all exterior hoses and attachments to the DWS are also warranted for defects in material and workmanship for one (1) year.

Multipure Solid Carbon Block Filters are warranted for defects in material and workmanship for use under normal care. The capacity of the filter cartridge depends upon the amount of impurities in the water to be processed.

Except as otherwise expressly provided above, Multipure makes no warranties, express or implied, arising by law or otherwise, including without limitation the implied warranties of merchantability and fitness for a particular purpose, to any person. This limited warranty may not be altered, varied, or extended except by a written instrument executed by Multipure. The remedy of repair or replacement as provided

under this limited warranty is exclusive. In no event shall Multipure be liable for any consequential or incidental damages to any person whether occasioned by negligence of the manufacturer, including without limitation damages of loss of use, cost of substitution, property damage, or other monetary loss.

Warranty is valid only if the DWS is operated within conditions listed herein. The warranty begins from the date of purchase.

Contaminant Reduction Performance



The Aquaperform is NSF-certified to reduce a broad array of contaminants of aesthetic and health concern. The following are contaminants treated by the Aquaperform.

NSF/ANSI 42 - Aesthetic Effects

Substance	Percent Reduction**	Influent challenge concentration (mg/L unless specified)	Maximum permissible product water concentration (mg/L unless specified)
CHLORAMINE as Aesthetic Effect (As Monochloramine)	>97.5%	3.0 +/- 10%	0.5
CHLORINE as Aesthetic Effect	99%	2.0 +/- 10%	> or = 50%
PARTICULATE, [Nominal Particulate Reduction, Class I, Particles 0.5 TO <1 µm	Class I > 99%	At Least 10,000 particles/mL	> or = 85%

NSF/ANSI 53 - Health Effects

Substance	Percent Reduction**	Influent challenge concentration (mg/L unless specified)	Maximum permissible product water concentration (mg/L unless specified)
ALACHLOR*	>98%	0.050	0.001
ARSENIC (pentavalent As (V); As (+5); arsenate @ 6.5 pH	>99.9%	0.050 +/- 10%	0.010
ARSENIC (pentavalent As (V); As (+5); arsenate @ 8.5 pH	>95.8%	0.050 +/- 10%	0.010
ASBESTOS	>99.9%	10 ⁶ to 10 ⁸ fibers/L; fibers greater than 10 micrometers in length	99% reduction requirement
ATRAZINE*	>97%	0.100	0.003
BENZENE*	>99%	0.081	0.001
BROMODICHLOROMETHANE (TTHM)*	>99.8%	0.300	0.015
BROMOFORM (TTHM)*	>99.8%	0.300	0.015
CARBOFURAN (Furadan)*	>99%	0.19	0.001
CARBON TETRACHLORIDE*	98%	0.078	0.0018
CHLORDANE	>99.5%	0.04 +/-10%	0.002
CHLOROBENZENE (Monochlorobenzene)*	>99%	0.077	0.001
CHLOROPICRIN*	99%	0.015	0.0002
CHLOROFORM (TTHM)* (surrogate chemical)	>99.8%	0.300	0.015
Cryptosporidium (CYST)	99.95%	minimum 50,000/L	99.95% reduction requirement
CYST (Giardia; Cryptosporidium; Entamoeba; Toxoplasma)	99.95%	minimum 50,000/L	99.95% reduction requirement

Substance	Percent Reduction**	Influent challenge concentration (mg/L unless specified)	Maximum permissible product water concentration (mg/L unless specified)
p-DICHLOROBENZENE (para-Dichlorobenzene)*	>98%	0.040	0.001
1,2-DICHLOROETHANE (1,2-DCA)*	95%	0.088	0.0048
1,1-DICHLOROETHYLENE (1,1-DCE)*	>99%	0.083	0.001
CIS-1,2-DICHLOROETHYLENE*	>99%	0.170	0.0005
TRANS-1,2-DICHLOROETHYLENE*	>99%	0.086	0.001
1,2-DICHLOROPROPANE (Propylene Dichloride)*	>99%	0.080	0.001
CIS-1,3-DICHLOROPROPYLENE*	>99%	0.079	0.001
DINOSEB*	99%	0.170	0.0002
EDB (see ETHYLENE DIBROMIDE)*	>99%	0.044	0.00002
ENDRIN*	99%	0.053	0.00059
Entamoeba (see CYSTS)	99.95%	minimum 50,000/L	99.95% reduction requirement
ETHYLBENZENE*	>99%	0.088	0.001
ETHYLENE DIBROMIDE (EDB)*	>99%	0.044	0.00002
Furadan (see CARBOFURAN)*	>99%	0.19	0.001
Giardia Lambdia (see CYST)	>99.95%	minimum 50,000/L	99.95% reduction requirement
HALOACETONITRILES (HAN)*			
BROMOCHLOROACETONITRILE	98%	0.022	0.0005
DIBROMOACETONITRILE	98%	0.024	0.0006
DICHLOROACETONITRILE	98%	0.0096	0.0002
TRICHLOROACETONITRILE	98%	0.015	0.0003
HALOKETONES (HK):*			
1,1-DICHLORO-2-PROPANONE	99%	0.0072	0.0001
1,1,1-TRICHLORO-2-PROPANONE	96%	0.0082	0.0003
HEPTACHLOR*	>99%	0.25	0.00001
HEPTACHLOR EPOXIDE*	98%	0.0107	0.0002
HEXACHLOROBUTADIENE (Perchlorobutadiene)*	>98%	0.044	0.001
HEXACHLOROCCYCLOPENTADIENE*	>99%	0.060	0.000002
LEAD (pH 6.5)	>99.3%	0.15 +/- 10%	0.010
LEAD (pH 8.5)	>99.3%	0.15 +/- 10%	0.010
LINDANE*	>99%	0.055	0.00001
MERCURY (pH 6.5)	>99%	0.006 +/- 10%	0.002
MERCURY (pH 8.5)	>99%	0.006 +/- 10%	0.002
METHOXYCHLOR*	>99%	0.050	0.0001
Methylbenzene (see TOLUENE)*	>99%	0.078	0.001
Monochlorobenzene (see CHLOROBENZENE)*	>99%	0.077	0.001
MTBE (methyl tert-butyl ether)	>96.6%	0.015 +/- 20%	0.005
POLYCHLORINATED BIPHENYLS (PCBs , Aroclor 1260)	>99.9%	0.01 +/- 10%	0.0005
PCE (see TETRACHLOROETHYLENE)*	>99%	0.081	0.001
PENTACHLOROPHENOL*	>99%	0.096	0.001
Perchlorobutadiene (see HEXACHLOROBUTADIENE)*	>98%	0.044	0.001
Propylene Dichloride (see 1,2-DICHLOROPROPANE)*	>99%	0.080	0.001
SIMAZINE*	>97%	0.120	0.004
Silvex (see 2,4,5-TP)*	99%	0.270	0.0016
STYRENE (Vinylbenzene)*	>99%	0.150	0.0005
1,1,1-TCA (see 1,1,1-TRICHLOROETHANE)*	95%	0.084	0.0046
TCE (see TRICHLOROETHYLENE)*	>99%	0.180	0.0010
1,1,2,2-TETRACHLOROETHANE*	>99%	0.081	0.001
TETRACHLOROETHYLENE*	>99%	0.081	0.001
TOLUENE (Methylbenzene)*	>99%	0.078	0.001
TOXAPHENE	>92.9%	0.015 +/- 10%	0.003
Toxoplasma (see CYSTS)	99.95%	minimum 50,000/L	99.95% reduction requirement
2,4,5-TP (Silvex)*	99%	0.270	0.0016
TRIBROMOACETIC ACID*		0.042	0.001
1,2,4 TRICHLOROBENZENE (Unsymtrichlorobenzene)*	>99%	0.160	0.0005
1,1,1-TRICHLOROETHANE (1,1,1-TCA)*	95%	0.084	0.0046
1,1,2-TRICHLOROETHANE*	>99%	0.150	0.0005

Substance	Percent Reduction**	Influent challenge concentration (mg/L unless specified)	Maximum permissible product water concentration (mg/L unless specified)
TRICHLOROETHYLENE (TCE)*	>99%	0.180	0.0010
TRIHALOMETHANES (THM) (Chloroform; Bromoform; Bromodichloromethane; Dibromochloromethane)	>99.8%	0.300	0.015
TURBIDITY	>99%	11 +/- 1 NTU	0.5 NTU
Unsym-Trichlorobenzene (see 1,2,4-TRICHLOROBENZENE)*	>99%	0.160	0.0005
Vinylbenzene (see STYRENE)*	>99%	0.150	0.0005
XYLENES (TOTAL)*	>99%	0.070	0.001

Arsenic Facts (in compliance with NSF/ANSI standards)

Arsenic (abbreviated As) is a naturally occurring contaminant found in many ground waters. Arsenic in water has no color, taste, or odor, and must be measured by lab testing. Public water utilities must have their water tested for arsenic, and their results can be obtained from your local water utility. If you have your own well, the water can be tested; your local health department or state environmental health agency can provide a list of certified testing labs. Information about arsenic in water can be found on the Internet at the U.S. Environmental Protection Agency website, at www.epa.gov/safewater/arsenic.html.

There are two forms of arsenic: pentavalent arsenic (also called As(V), As(+5), and arsenate) and trivalent arsenic (also called As(III), As(+3), and arsenite). In well water, arsenic may be pentavalent, trivalent, or a combination of both. Special sampling procedures are needed for a lab to determine what type and how much of each type of arsenic is in the water. Check with the labs in your area to see if they can provide this type of service.

Specially formulated Carbon Block systems are very effective at removing pentavalent arsenic. A free chlorine residual will rapidly convert trivalent arsenic to pentavalent arsenic. Other water treatment chemicals such as ozone and potassium permanganate will also change trivalent arsenic to pentavalent arsenic. A combined chlorine residual (also called chloramine) may not convert all the trivalent arsenic. If you get your water from a public water utility, contact the utility to find out if free chlorine or combined chlorine is used in the water system.

The Multipure Aquaperform is designed to remove only pentavalent arsenic. The Aquaperform will not convert trivalent arsenic to pentavalent arsenic. The system may remove some trivalent arsenic; however, it has not been evaluated for its ability to remove trivalent arsenic. The system was tested in a laboratory to remove pentavalent arsenic. Under lab conditions, as defined in ANSI/NSF Standard 53, the system reduced 0.050 mg/L (ppm) pentavalent arsenic to 0.010 mg/L (ppm) (the U.S. EPA standard for drinking water) or less. The performance of the system may be different at your installation. Have the treated water tested for arsenic to check if the system is working properly.

The Carbon Block filter component of the Aquaperform system must be replaced as indicated in this User Guide to ensure the system will continue to remove arsenic and other contaminants.

Footnotes

*Chloroform was used as a surrogate for claims of reduction of Volatile Organic Chemicals (VOC). Multipure Systems tested at >99.8% actual reduction of Chloroform. Percent reduction shown herein reflects the allowable claims for VOCs as per tables in the Standard.**Percent reduction shown herein reflects actual performance of Multipure product as specifically tested (at 200% of capacity). Percent reduction shown for VOCs reflects the allowable claims for Volatile Organic Chemicals/Compounds as per Tables. Chloroform was used as a surrogate for VOC reduction claims: the Multipure Systems' actual reduction rate of Chloroform was >99.8% as tested (at 200% of capacity). ***NSF Standard 401 has been deemed as "incidental contaminants / emerging compounds". Incidental contaminants are those compounds that have been detected in drinking water suppliers at trace levels. While occurring at only trace levels these compounds can affect the public acceptance/perception of drinking water quality.

1. **Do not use with water that is microbiologically unsafe or with water of unknown quality without adequate disinfection before or after the unit. Systems certified for cyst reduction may be used on disinfected waters that may contain filterable cysts.**
2. Multipure Drinking Water Systems have been certified, as indicated, by NSF International for compliance to NSF/ANSI Standard Nos. 42 & 53.
3. The Multipure Drinking Water Systems have been certified by the State of California Department of Public Health for the reduction of specific contaminants listed herein.
4. Chloroform was used as a surrogate for claims of reduction of VOCs. Multipure Systems tested at >99.8% actual reduction of Chloroform. Percent reduction shown herein reflects the allowable claims for VOCs as per tables in the Standard.
5. The systems have been tested for the treatment of water containing pentavalent arsenic.
6. Do not use with water that is microbiologically unsafe or of unknown quality without adequate disinfection before or after the system. Systems certified for cyst reduction may be used on disinfected water that may contain filterable cysts.
7. Filter life will vary in proportion to the amount of water used and the level of impurities in the water being processed. For optimum performance, it is essential that the filter be replaced on a regularly scheduled basis as follows: (a) annually; (b) when the unit's rated capacity has been reached; (c) the flow rate diminishes; (d) the filter becomes saturated with bad tastes and odors.
8. Model No. MP880EL includes a capacity monitor that automatically flashes a red light when it is time to replace your filter.
9. Multipure Drinking Water System Housings are warranted for Lifetime (provided that the filter be replaced at least once a year); all exterior hoses and attachments to the System are warranted for one year. Please see the Owner's Manual for complete product guarantee and warranty information.
10. Please see the Owner's Manual for installation instructions and operating procedures.
11. In compliance with New York law, it is recommended that before purchasing a water treatment system, NY residents have their water supply tested to determine their actual water treatment needs. Please compare the capabilities of the Multipure unit with your actual water treatment needs.
12. While testing was performed under standard laboratory conditions, actual performance may vary.
13. The list of substances which the treatment device reduces does not necessarily mean that these substances are present in your water.

Troubleshooting

Water flow is frequently interrupted by air

Purge any residual air from the system:

1. Turn the system housing upside down.
2. Turn on the filtered water faucet (either through the Aquaperform faucet or the diverter valve).
3. Allow water to flow for one minute while holding the housing upside down.
4. Turn off the filtered water faucet (either through the Aquaperform faucet or the diverter valve).

Odor – rotten eggs, no discoloration on the filter

A rotten egg odor is a sign that H₂S (hydrogen sulfide) gas is present in your water source.

If hydrogen sulfide gas is present in your water source, it is recommended that you rotate DWS usage between 2 filter cartridges. When the DWS emits the rotten egg smell, remove the filter and allow it to dry upside down to allow the gas to dissipate (the filter can be reused once dry). Use the second filter in the unit while the first filter is drying.

Odor – rotten eggs, with discoloration on the filter

A rotten egg odor is a sign that H₂S (hydrogen sulfide) is present in your water source. Filter discoloration can determine the source:

- orange/brownish colors – iron
- blackish colors – manganese
- slimy/blotchy colors – decaying organisms

When hydrogen sulfide comes from a source that discolors the filter cartridge and creates a strong rotten egg odor, the only recommended solution is to change the filter cartridge.

Color – milky color in the water

Milky color in the water is typically caused by air bubbles in the water. Higher than normal water pressure through the DWS can create these small air bubbles, but they do not affect system performance. Air in the water may also be the result of conditions in your municipal water supply.

For countertop systems, turn on the water and engage the diverter valve while slightly reducing the water flow. Less water pressure through the system can prevent air bubbles from forming.

For below-sink systems, adjust the water pressure at the feedwater adapter below the sink.

Color – black color in the water

Black color in the water is typically caused by residual carbon dust from the filter.

Allow water to run through the DWS for approximately 30 minutes to flush the filter. Residual carbon dust may initially color the water black.

Flow rate – the water flow rate is slow

The filter is designed to restrict its flow rate when clogged with particulates or other solid contaminants.

When the water flow rate slows to the point of inconvenience, it is time to replace the filter cartridge. If other water sources are on while using the DWS, turn them off to check if they are affecting the flow rate.

Taste/Odor – miscellaneous

The carbon block filter may have become saturated with the tastes and odors treated in your drinking water.

To resolve this, change the filter.

Frequently Asked Questions

Will low pH or acidic water affect the filter?

No. Mineral components can determine the pH of water, and minerals dissolved in solution in the water pass through the system unfiltered.

- pH 7 = neutral
- pH > 7 = alkaline
- pH < 7 = acidic

Does deionized water or soft water have an effect on Multipure water?

No. Because Multipure filters do not treat the natural minerals dissolved in water, the hardness or softness of water has no effect on the resultant filtered Multipure water.

Can the Multipure system be connected to an icemaker?

The Aquaperform can be connected to the sink, refrigerator, water dispenser, or icemaker.

Can the Multipure system be used during an emergency or when the water is turned off?

Yes. During an emergency or when the source water is off, you can hand pump or siphon water through the Multipure system.

CAUTION: The Multipure system is not intended for use where the water is microbiologically unsafe or with water of unknown quality without adequate disinfection before or after the unit. To disinfect questionable source water, add 1/4 tsp. of household bleach per gallon of source water; the Multipure system will remove this solution from the water during the filtering process. Hand pump kits and emergency kits are available from Multipure.

What causes white particles to appear in Multipure water when it is frozen or boiled?

Because the Aquaperform does not reduce any natural minerals present in water, these minerals may solidify when the water is frozen and appear as white flakes or specks when the water is melted or boiled.

Many natural minerals in water are beneficial to your health, and their existence in drinking water (in normal quantities) is not cause for alarm. Minerals can be removed by Reverse Osmosis technology, which is available through the Multipure AquaRO Drinking Water System.

Why does the Multipure system reduce Volatile Organic Chemicals, but not natural minerals?

Minerals are dissolved in solution and do not have an actual physical size; thus, the minerals pass through the system unfiltered.

Should sediment be removed with a standard filter first?

In areas with excessive sedimentation, pre-filtration can help extend the operational efficiency of the Multipure filter; however, in most areas it is unnecessary.

Multipure Drinking Water Systems utilize a double-filter mechanic. The outer material is a pre-filter that protects the solid carbon block from prematurely clogging with large sediment.

Why is the compressed solid carbon block filter more efficient than (loose) granular activated carbon filters?

Multipure's densely compacted solid carbon block filters force water through microscopic pores of carbon – much smaller than those of granular activated carbon – thus more effectively reducing particulate matter and contaminants that affect the taste and odor of the water.

What is the difference between a “water softener” and a Multipure Drinking Water System?

Water softeners are not designed to treat drinking water for contaminants; instead, they are designed to adjust the hardness (mineral content) of the water. Multipure systems do not remove dissolved minerals from the water, because natural minerals often found in water are considered beneficial to good health.

Soft water is often desirable for bathing and laundering purposes, and may extend the life of hot water heaters and boilers. However, soft water is not recommended for use on plants or lawns. Multipure recommends that you bypass a water softener when installing your Multipure Drinking Water System.

Can the Multipure Drinking Water System be used with untreated water?

Multipure systems are designed to be used with municipally treated water; they are not intended to be used where the water is microbiologically unsafe or with water of unknown quality without adequate disinfection before or after the unit. Systems certified for cyst reduction may be used on disinfected waters that may contain filterable cysts. To disinfect questionable source water, add 1/4 tsp of household bleach per gallon of source water; the Multipure system will remove this solution from the water during the filtering process.

Aquaperform Accessories

Below-Sink Kit

This installation kit includes a stand-alone chrome faucet and the necessary hardware to install the system below the sink. The system connects to the cold water line with an included Adapta Valve, and the faucet requires a 0.5" hole available in the countertop or sink for installation.

A below-sink Aquaperform can be removed and converted for countertop use with additional parts.

Countertop Kit

This installation kit includes a dual-hose diverter valve to connect to the sink faucet, providing push-button selection of either filtered or unfiltered water.

A countertop Aquaperform is generally intended for use where below-sink installation restrictions are present (e.g., apartment use or lack of below-sink space), although it can be converted for below sink use with additional parts.

Aquaperform Replacement Filter (CB11As)

The Aquaperform replacement filter utilizes Solid Carbon Block technology for optimal performance, and is certified to treat aesthetic contaminants, health contaminants and emerging compounds.

More Information and Products at
www.multipure.com

If this device is not maintained or operated as specified in this owner's manual, there is a risk of exposure to contaminants. This drinking water filtration system is certified for the reduction of contaminants such as Lead, Mercury, VOCs, Cysts & Toxaphene. For the complete list of contaminants and more information, visit the manufacturer's website at www.multipure.com or the California State Water Resources Control Board at <http://www.waterboards.ca.gov/>.

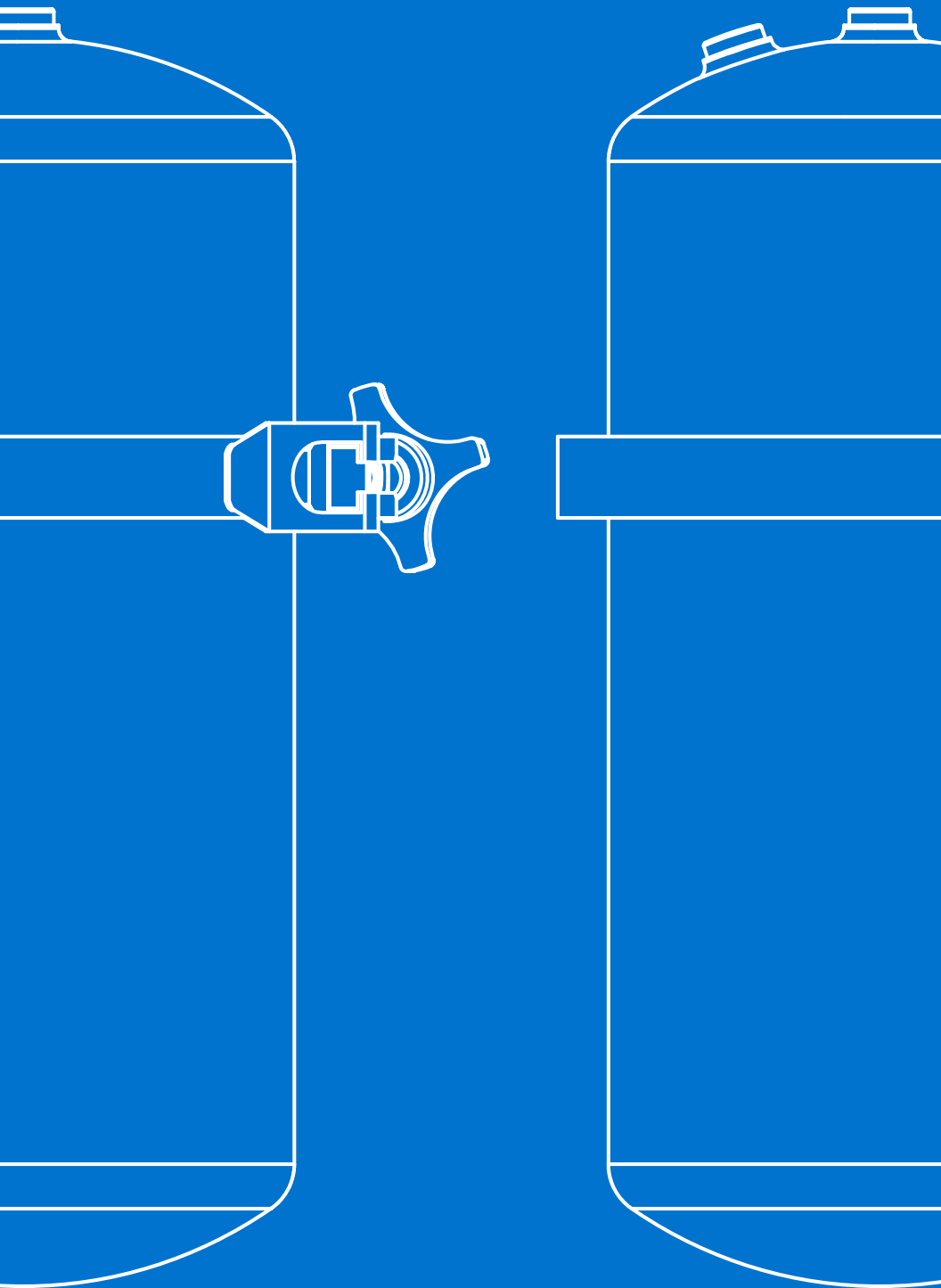



Taste The Difference[®]

7251 Cathedral Rock Drive, Las Vegas, NV 89128
702.360.8880 • 800.622.9206 • www.multipure.com